

Thank you for purchasing our 180-Xray Chassis



180-Xray Chassis

for Howa/Weatherby Vanguard

Contents of Package:

- 180-Xray Chassis assembled
- Baggie with following contents:
 - Rear action screw: 1ea socket head screw M6 X 45MM
 - Front action screw: 1 ea socket head screw M6 X 16MM
 - Washer: 1ea for front action screw
 - Flat nut: 3ea M5 metric for attaching accessories to forend
 - Hex nut: 4ea M5 metric for attaching accessories to forend
- Baggie with 1-3 LOP spacer kit (3x LOP spacers and 3 sets of screws with washers) (X-ray back end only)

Installation Instructions:



Safety Warning: Before you attempt any installation, make sure your rifle is unloaded. Also, before starting remove the bolt and magazine from the rifle.

Part I: Remove action from existing chassis/stock

Step 1: Loosen the screws that hold the action into the stock. Next pull the barreled action out of the stock and remove any attached box magazine parts.

Part II: Install your action into the 180-Xray Chassis

Step 1: Install front action screw. To do this, drop the action screw and washer into place through the bottom of the backbone section.

Step 2: Lower the chassis down onto the action bedding area and turn the front action screw to engage the threads in the action to draw the action into the chassis, do not fully tighten at this point.

Step 3: Drop the rear action screw into the hole in the trigger guard, turn the screw to engage the threads in the action. Again do not fully tighten.

Step 4: Pull the action towards the rear of the stock while holding the stock stationary. This is to seat the action against the recoil lug abutment of the chassis.

Step 5: Next tighten both action screws until they are snug but not fully tightened.

Step 6: Torque both screws to 65 in-lbs of torque in an incremental manner, moving back and forth between the two screws until full torque is reached. We recommend experimenting with the torque settings to find the best accuracy for your rifle. In our experience, some rifles shoot better with less than 65 in-lbs. Lubricating the action screws with oil or heavy grease will ensure that they hold tension even at lower torque settings (in fact lower torque values are suggested for lubricated fasteners).

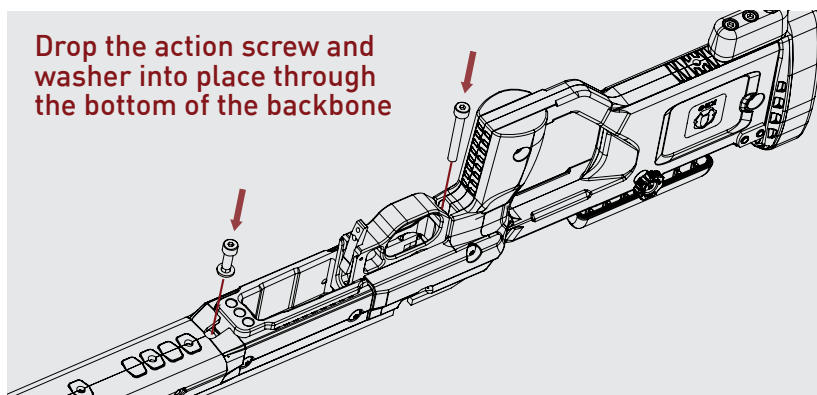

Time to adjust the stock to fit you!

Length of Pull (LOP) Adjustment

Step 1: Remove the buttpad using a 3mm metric hex/allen wrench. Don't lose the T-nuts that are housed in the buttpad mount plate!

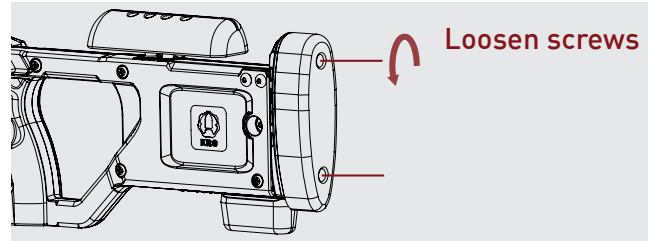

Step 2: Loosen but do not remove the two M5 button head screws that hold the buttplate mount onto the buttstock. Once loose, the mount plate can be shifted up or down. There are notches in the mount plate that correspond to protrusions on the buttstock. Line these two features up at your desired height and retighten the two screws. We recommend a buttplate in a higher position for prone shooting and a lower position for bench shooting or where your body is more upright.

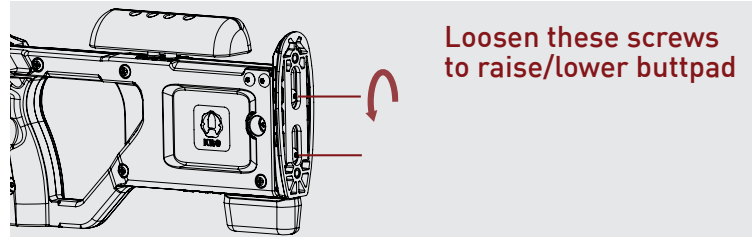

Step 3: Push the installed M5 buttplate mount screws out of the buttplate. Replace these screws with the longer screws which are long enough to go through your desired amount of spacers. Insert desired quantity of spacers onto the longer screws.

Remove buttplate screws

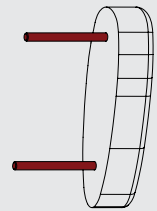

Step 4: Install the buttplate back onto the buttplate mount plate with the spacers captured between them.

Install buttplate onto mount plate

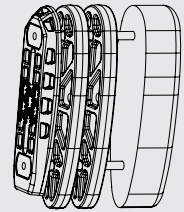

Cheek Height Adjustment

Tool-less cheek height adjustment with a simple return to zero feature

Step 1: Loosen the thumbscrew and remove the cheek piece, then slide the o-rings toward the bottom of the riser posts and re-insert the cheekpiece.

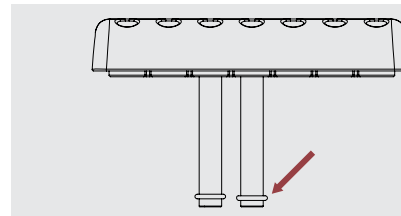

Step 2: Getting into position behind the rifle, place your head gently on the cheekpiece. The cheekpiece should be too high for a proper view through the scope. With the thumbscrew slightly loose, push the cheekpiece down with your head until it rests in the proper position so you have a perfect view through the scope. Tighten the thumbscrew to lock the cheekpiece in that position. When you need to remove the rifle bolt from the action for cleaning, the o-rings will keep the position you selected when you re-install the cheek piece.

Step 3: Optional – You can move the cheek piece forward and backward by removing the two screws holding the cheek piece to the two cheek riser posts and then switching the holes in which the riser posts sit. (use 3mm hex wrench).

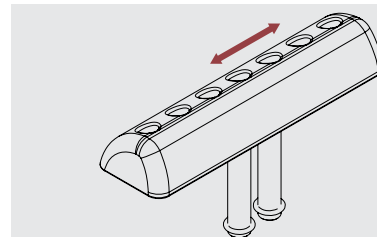

Accessories Mounting

A variety of accessories can be mounted to your 180-Xray chassis. These include:

- MOE L2 and L3 rails from Magpul as well as the aluminum L2 and L3 versions made by KRG
- QD sling plate, Sling Loop/QD mount, and Sling Loop Screw made by KRG
- Night Vision Mount Cap made by KRG
- Large grips made by KRG
- many other items/combinations possible

Forend Mounting

Accessories mounted to the forend will require the forend to be taken apart into two halves. One half can be left attached to the chassis. With the two halves apart, mount the accessory into one half using the backer nuts provided (flat nuts or hex nuts). With items mounting to the sides of the forend, you can epoxy the hex nuts into their pockets to hold them in place to make mounting the item easier. Below is an example of mounting an item to the forend:

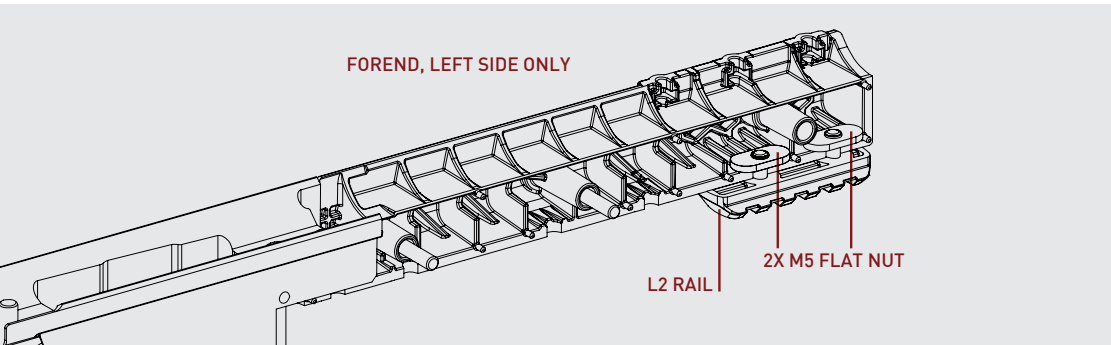

Mounting Options Data

